

MAXIM

Palmtop Computer and Flash Memory Power-Supply Regulators

MAX717-721/EV KIT

General Description

The MAX717-MAX721 CMOS power-supply ICs create dual, regulated DC outputs for small, battery-operated microprocessor systems. Each device generates a main output (3V or 5V, selectable) and an auxiliary output for flash memory or PCMCIA (5V or 12V, selectable). Each device accepts up to three input voltages. Power can come from a main battery (two or three alkaline or NiCad cells), a lithium backup battery, or an unregulated DC source such as an AC-DC wall adapter.

The MAX717-MAX721 provide three improvements over prior-art devices. Physical size is reduced – the high switching frequencies (up to 0.5MHz) made possible by MOSFET power transistors allow for tiny (<5mm diameter) surface-mount magnetics. Efficiency is improved to 87% (10% better than with low-voltage regulators made in bipolar technology). And supply current is reduced to 60µA by CMOS construction and a unique constant-off-time pulse-frequency modulation (PFM) control scheme.

The MAX717-MAX721 differ only in shutdown and status functions and in the choice of a 3.0V or 3.3V main output (see *Device Options*).

For LCD-bias applications requiring an adjustable negative voltage, refer to the MAX722/MAX723 data sheet.

Applications

- Palmtop Computers
- Flash-Memory/PCMCIA Power Supplies
- Portable Data-Collection Equipment
- Medical Instrumentation
- Portable Data Communicators

Pin Configurations

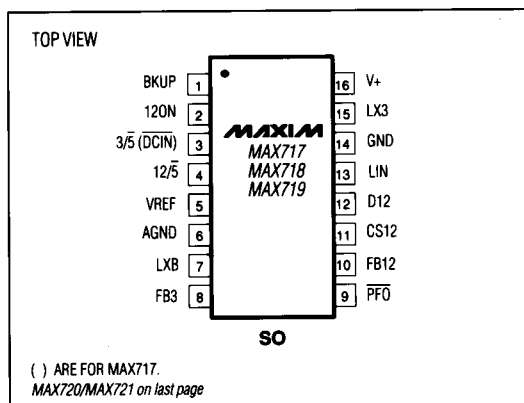

Features

- ◆ Low 0.9V to 5.5V Battery Operating Range
- ◆ Unregulated 7V to 20V DC Input Range
- ◆ Dual Regulated Outputs
Main Output: 3.3V/5V
Auxiliary Output: 5V/12V
- ◆ 87% Efficiency at 200mA
- ◆ Efficiency PRAM Keep-Alive: 80% at 1mA
- ◆ 8W/in³ Power Density
- ◆ 60µA Quiescent Current
- ◆ 20µA Shutdown Mode with VREF Alive (MAX720/MAX721 only)
- ◆ 500kHz Maximum Switching Frequency
- ◆ ±1.5% VREF Tolerance Over Temp
- ◆ Detect Output Power Failures
- ◆ Detect Presence of AC Power
- ◆ 16-Pin Narrow SO Packages

Ordering Information

PART	TEMP. RANGE	PIN-PACKAGE
MAX717CSE	0°C to +70°C	16 Narrow SO
MAX717C/D	0°C to +70°C	Dice*

Ordering Information continued on last page.

* Contact factory for dice specifications.

Typical Operating Circuit

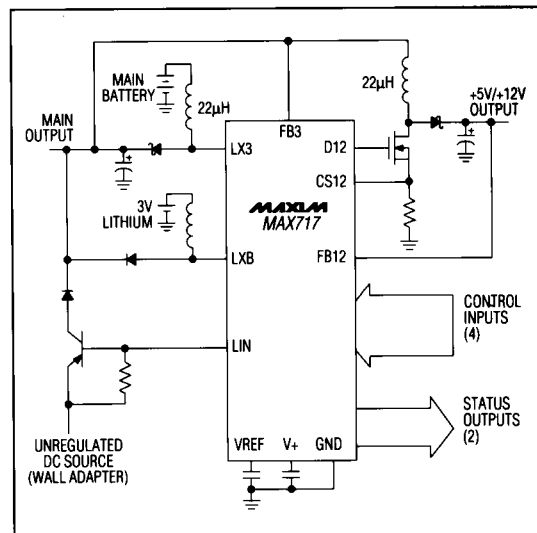

Palmtop Computer and Flash Memory Power-Supply Regulators

ABSOLUTE MAXIMUM RATINGS

Supply Voltage (V+ to GND)	+7V, -0.3V	Continuous Power Dissipation	
Switch Voltage (LX3 to GND)	+7V, -0.3V	up to +70°C	696mW
Linear-Regulator Voltage (LIN to GND)	+20V, -0.3V	derate above +70°C	8.70mW/°C
Feedback Voltage (FB12 to GND)	+13V, -0.3V	Operating Temperature Ranges:	
Auxiliary Pin Voltages		MAX7_CSE	0°C to +70°C
(12ON, 3/5, 12/5, SHDN, LXB, BKUP, VREF,		MAX7_ESE	-40°C to +85°C
PFO, DCIN, CS12, D12 to GND)	-0.3V to (V+ + 0.3V)	Junction Temperature	+150°C
Ground Voltage Difference (AGND to GND)	±0.3V	Storage Temperature Range	-65°C to +160°C
Reference Current (IvREF)	2.5mA	Lead Temperature (soldering, 10 sec)	+300°C

Stresses beyond those listed under "Absolute Maximum Ratings" may cause permanent damage to the device. These are stress ratings only, and functional operation of the device at these or any other conditions beyond those indicated in the operational sections of the specifications is not implied. Exposure to absolute maximum rating conditions for extended periods may affect device reliability.

ELECTRICAL CHARACTERISTICS

(Circuit of Figure 1, VBATT1 = VBATT2 = 2.5V, TA = TMIN to TMAX, unless otherwise noted.)

PARAMETER	CONDITIONS		MIN	TYP	MAX	UNITS	
Main Output Voltage - Main SMPS Mode	2V < VBATT1 < 3V, 0mA < ILOAD < 200mA, DC SOURCE = BKUP = 0V (Note 1)	3/5 = 3V	MAX717/718/720	3.17	3.30	3.43	V
			MAX719/MAX721	2.88	3.00	3.12	
		3/5 = 0V		4.80	5.00	5.20	
Main Output Voltage - Linear-Regulator Mode	7V < DC SOURCE < 18V, 0mA < ILOAD < 500mA, BKUP = 0V	3/5 = 3V	MAX717/718/720	3.17	3.30	3.43	V
			MAX719/MAX721	2.88	3.00	3.12	
		3/5 = 0V		4.80	5.00	5.20	
Main Output Voltage - Backup Mode	BKUP = 3V, 3/5 = 3V, 2V < VBATT3 < 3V, 0mA < ILOAD < 1mA		MAX717/MAX718	3.17	3.30	3.43	V
			MAX719	2.88	3.00	3.12	
Auxiliary Output Voltage	2V < VBATT2 < 4V, VBATT1 = 2.5V, ILOAD = 0mA	12/5 = 0V		4.80	5.00	5.20	V
		12/5 = 3V		11.54	12.00	12.48	
Minimum Start-Up Supply Voltage (VBATT1)	ILOAD = 0mA			1.4	1.8	V	
Minimum Start-Up Supply Voltage (DCIN)				7.3	7.6	V	
Current-Sense Limit Threshold	Measured at CS12, 3/5 = 3V		170	200	230	mV	
Drive Output Current	Measured at D12, 3/5 = 3V			±150		mA	
Linear-Regulator Output Sink Current	LIN = 6V, 3/5 = 3V, measured at LIN		20	50		mA	
Quiescent Supply Current from 3VOUT (Note 2)	12ON = 0V, 3/5 = 3V, BKUP = 0V or 3V, FB3 forced to 3.47V (MAX717/718/720), FB3 forced to 3.15V (MAX719/MAX721)				60	µA	
Battery Quiescent Current (VBATT1 + VBATT2)	12ON = 0V, 3/5 = 3V, BKUP = 0V or 3V			60		µA	
Shutdown Battery Current	MAX720/MAX721, SHDN = 0V			20	40	µA	
Battery Quiescent Current - Linear-Regulator Mode	DC source = 7V, 3/5 = 0V, measured at VBATT1		-10		10	µA	
Backup-Battery Quiescent Current - Backup Mode	DC source = 0V, BKUP = 3V, 3/5 = 3V, measured at VBATT3, forced to 3V			70		µA	
Backup-Battery Current - Main Mode	DC source = 0V, BKUP = 0V, 3/5 = 0V, measured at VBATT3, forced to 3V		-1		1	mA	

Palmtop Computer and Flash Memory Power-Supply Regulators

MAX717-721/EV KIT

ELECTRICAL CHARACTERISTICS (continued)

(Circuit of Figure 1, VBATT1 = VBATT2 = 2.5V, TA = TMIN to TMAX, unless otherwise noted.)

PARAMETER	CONDITIONS	MIN	TYP	MAX	UNITS
Backup-Battery Current – Linear-Regulator Mode	DC source = 7V, 3/5 = 0V, measured at VBATT3, forced to 3V	-1		1	μA
Reference Voltage	No VREF load	1.23	1.25	1.27	V
Reference Load Regulation	3/5 = 3V, -20μA < VREF load < 250μA TA = +25°C TA = TMIN to TMAX		10	20 25	mV
Power-Fail Threshold	3/5 = 0V or 3V, falling edge, referred to no-load output voltage	-4	-6	-8	%
Power-Fail Hysteresis	3/5 = 0V or 3V		2		%
PFO, DCiN Output Voltage Low	ISINK = 2mA, 3/5 = 12ON = 0V			0.4	V
PFO, DCiN Output Current High	VOU = 2.8V, 3/5 = 3V			1	μA
Logic Input Voltage Low	Measured at 12ON, 12/5, BKUP, 3/5, SHDN			0.4	V
Logic Input Voltage High	Measured at 12ON, 12/5, BKUP, 3/5, SHDN	1.6			V
Logic Input Current				±100	nA

Note 1: The main SMPS output voltage at full load current is guaranteed by measuring LX3 switch on resistance and peak current-limit threshold.

Note 2: Supply current from 3VOUT is measured with an ammeter between the main output 3VOUT and FB3. This current correlates directly with actual battery supply current, but decreases in value according to step-up ratio and efficiency.

Typical Operating Characteristics

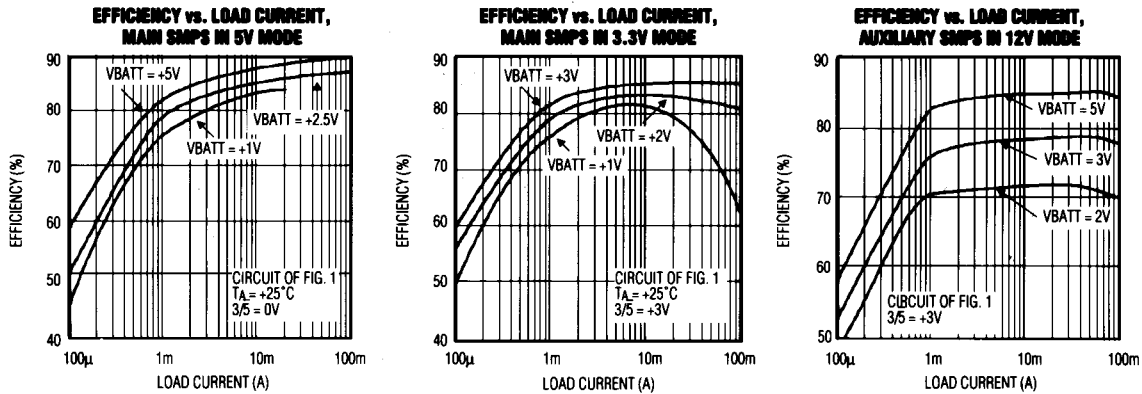

Palmtop Computer and Flash Memory Power-Supply Regulators

Typical Operating Characteristics (continued)

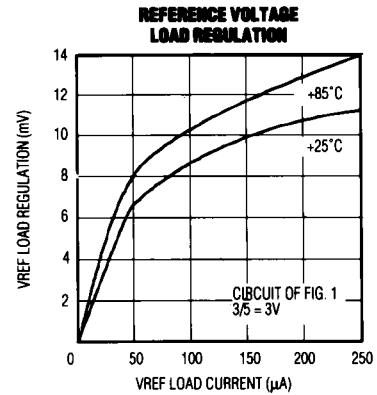
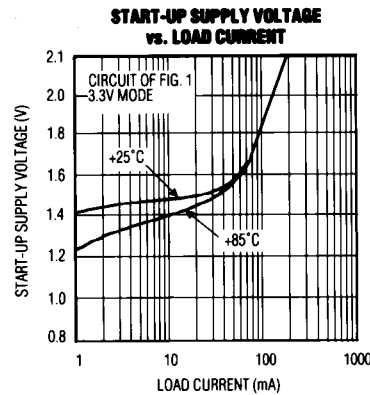
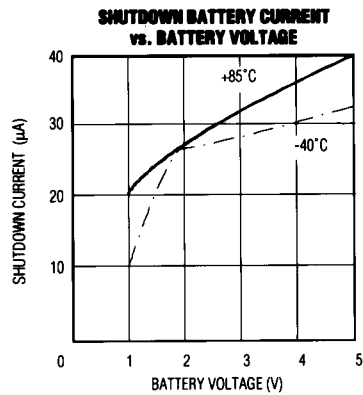
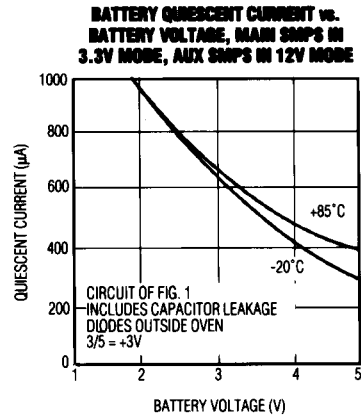
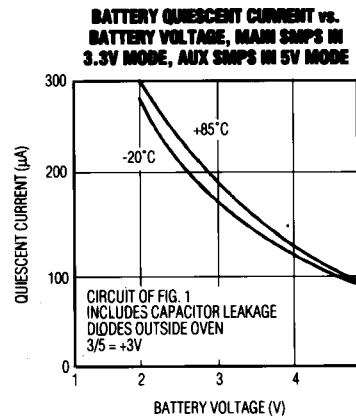
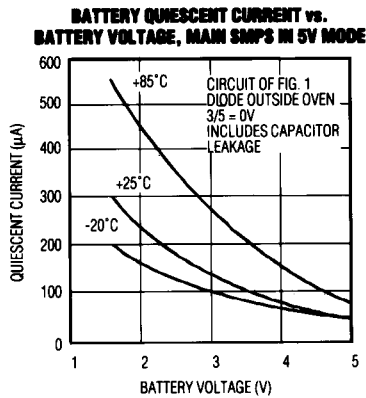
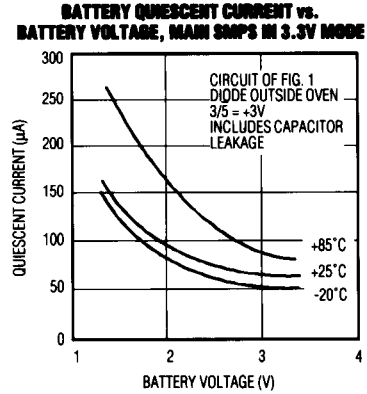
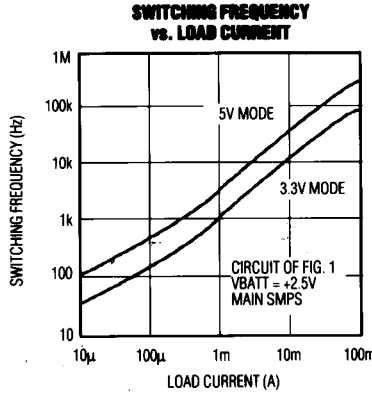
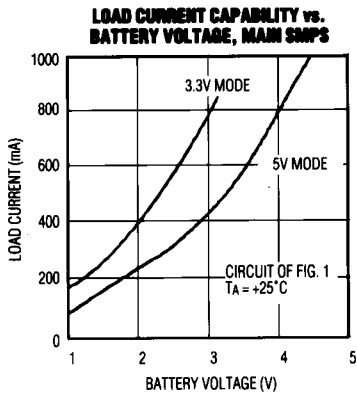

Palmtop Computer and Flash Memory Power-Supply Regulators

Typical Operating Characteristics (continued)

MAX717-721/EV Kit

MAIN SMPS LOAD-TRANSIENT RESPONSE

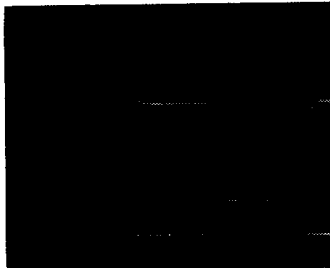

A = OUTPUT VOLTAGE,
50mV/div

B = LOAD CURRENT,
0mA TO 200mA

VBATT = 2.5V
HORIZONTAL = 50 μ s/div
3/5 = 0V

DC-SOURCE SWITCHOVER - MAIN SMPS TO LINEAR



A = DC SOURCE,
0V to +12V

B = OUTPUT VOLTAGE,
50mV/div

I_{LOAD} = 200mA
HORIZONTAL = 200 μ s/div
3/5 = 0V

MAIN SMPS START-UP DELAY TIME

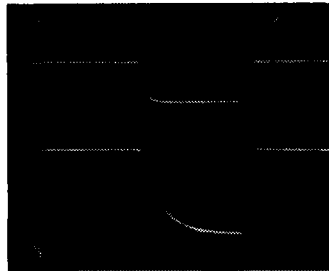

A = BATTERY VOLTAGE,
0V TO 2.5V

B = OUTPUT VOLTAGE,
2V/div

I_{LOAD} = 100mA
HORIZONTAL = 5ms/div
3/5 = 0V

Palmtop Computer and Flash Memory Power-Supply Regulators

Pin Description

PIN			NAME	FUNCTION
MAX717	MAX718/719	MAX720/721		
1	1	—	BKUP	Battery Backup. When BKUP input is high, the lithium backup SMPS is on and the main SMPS is off.
—	—	1	SHDN	Shutdown Input disables both SMPSs when low, but the reference remains alive. If the linear regulator is powered up, SHDN is overridden.
2	2	2	12ON	12V SMPS On/Off Control Input enables the auxiliary (5V/12V) SMPS when high.
—	3	3	3 $\bar{5}$	Selects the main output voltage setting; 5V when low.
3	—	4	DCIN	Detects presence of a DC source. Open-drain output; goes low when LIN is pulled high.
4	4	5	12 $\bar{5}$	Selects the auxiliary output voltage setting, 12V when high.
5	5	6	VREF	1.250V Reference Voltage Output. Bypass with 0.22 μ F capacitor to AGND (0.1 μ F if there is no external reference load). Maximum load capability is 250 μ A source, 20 μ A sink.
6	6	7	AGND	Quiet Analog Ground
7	7	—	LXB	N-Channel MOSFET Drain for the lithium backup SMPS
8	8	8	FB3	Feedback Input for the main output (for all modes)
9	9	9	PFO	Power-Fail Output – an open-drain output that goes low to indicate the main output is out of regulation by 6% or more.
10	10	10	FB12	Feedback Input for the auxiliary (+12V) SMPS
11	11	11	CS12	Current-Sense Input for the +12V SMPS controller. 200mV corresponds with the maximum current-limit threshold.
12	12	12	D12	Driver for the +12V SMPS N-Channel Power MOSFET. Swings from GND to V+.
13	13	13	LIN	Linear-Regulator Controller Output drives external PNP pass transistor. Open-drain N-channel output. The main SMPS automatically shuts off when the voltage at LIN reaches 7.3V, and turns back on when LIN falls to 6.5V.
14	14	14	GND	Power Ground
15	15	15	LX3	1.2A, 0.4 Ω N-Channel Power MOSFET Drain for the main SMPS
16	16	16	V+	IC Substrate, automatically switched to the most positive of either the main output or the auxiliary (+12V) output. Bypass to GND with 0.1 μ F.

Possible Dual-Output Voltage Combinations

- 3.3V and 5V
- 3.3V and 12V
- 5V and 12V
- 5V and 5V (independently controlled)
- 3.0V versions are available.

Device Options

All devices include an identical 5V-/12V-selectable auxiliary SMPS, a linear regulator, a precision reference, and a power-fail detector. The MAX720 and MAX721 are intended for systems requiring direct battery switchover in backup mode instead of a regulated backup supply.

Therefore, those devices have a total shutdown mode in place of the low-power lithium-backup SMPS mode. The MAX717 has no 5V setting for its main SMPS.

Device	Main Output	DCIN Detect Output	Lithium-Backup Power Supply	Total Shutdown
MAX717	3.3V Fixed	Yes	Yes	No
MAX718	3.3V/5V Switched	No	Yes	No
MAX719	3.0V/5V Switched	No	Yes	No
MAX720	3.3V/5V Switched	Yes	No	Yes
MAX721	3.0V/5V Switched	Yes	No	Yes

Palmtop Computer and Flash Memory Power-Supply Regulators

Detailed Description

Operating Principle

The MAX717 combines three step-up switch-mode regulators, a linear regulator, a precision voltage reference, a power-fail detector, and a DCIN detector that indicates the presence of an external AC-DC source (Figure 2). For maximum integration, the MAX717 series ICs contain an internal N-channel power MOSFET for the main low-voltage boost converter. This MOSFET is a 'sense-fet' type for best efficiency, and has a very low gate-threshold voltage to ensure start-up under low battery-voltage conditions (1.4V typ). The +12V auxiliary controller exploits an external logic-level N-channel MOSFET for the higher-voltage requirement.

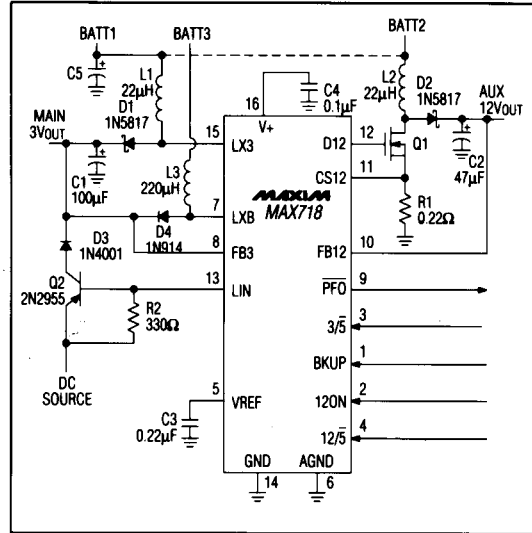

Figure 1. Standard Application Circuit

MAX717-721/EV KIT

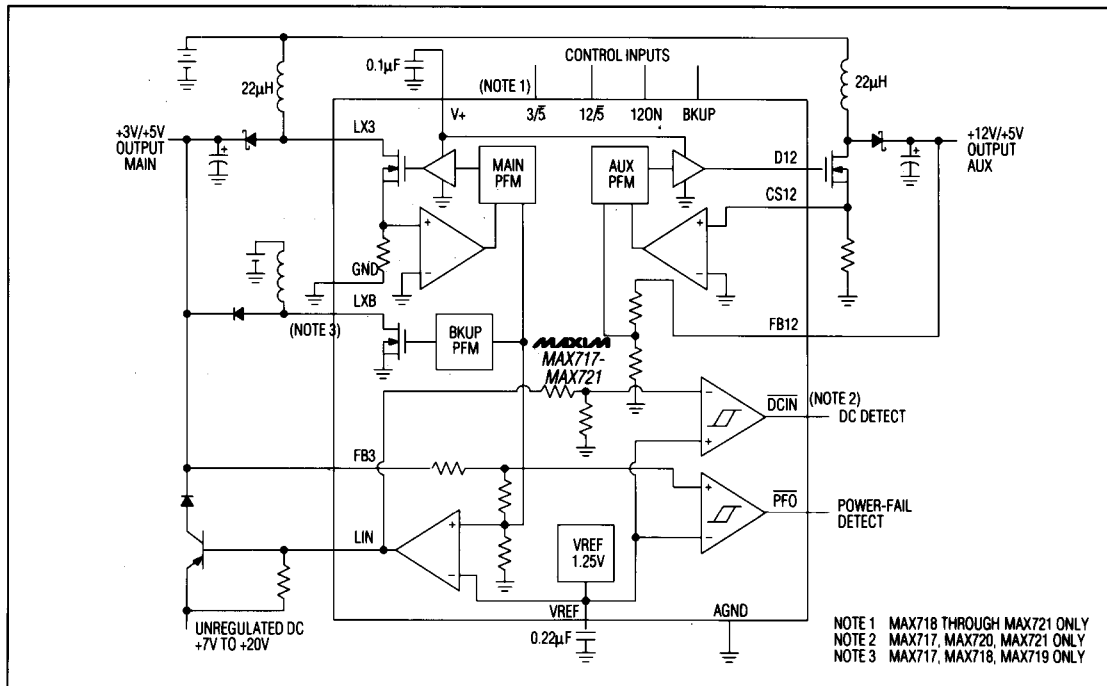

Figure 2. MAX717-MAX721 Block Diagram

Palmtop Computer and Flash Memory Power-Supply Regulators

Pulse-Frequency Modulation Control Scheme

A unique minimum-off-time, current-limited, pulse-frequency modulation (PFM) control scheme is a key feature of both the main and auxiliary regulators (Figure 3). This PFM scheme combines the advantages of pulse-width modulation (PWM) (high output power and efficiency) with those of a traditional PFM pulse-skipper (ultra-low quiescent currents). There is no oscillator; switching is accomplished through a constant peak-current limit in the switch, which allows the inductor current to self-oscillate between this peak limit and some lesser value. Switching frequency is governed by a pair of one-shots, which set a minimum off-time (1 μ s) and a maximum on-time (4 μ s). Under light loads, the peak inductor current rises to about one-half the current limit (for best light-load efficiency). Under heavy loads, the peak inductor current rises until it hits the current limit, whereupon the MOSFET switch turns off for the minimum off-time set by a one-shot. Continuous-conduction mode results, which minimizes peak currents and component stresses for a given load. The only disadvantage of this architecture compared to full PWM operation is the variable-frequency switching noise. However, the noise does not exceed the current limit times the filter capacitor equivalent series resistance (ESR), unlike conventional pulse-skippers.

Main 3V/5V Switch-Mode Regulator

The main output voltage can be selected to 3.3V or 5V under logic control, or it can be left in one mode or the other by tying 3/5 to ground or FB3. Efficiency varies depending on the battery and load, and is typically better than 80% over a 1mA to 200mA load range. The device is internally bootstrapped; power to the device is derived from the main output voltage (via FB3) or the auxiliary output voltage (via FB12), whichever is higher. When the output is set at 5V instead of 3.3V, the higher internal supply voltage results in lower switch-transistor on resistance and slightly greater output power. Bootstrapping allows the battery voltage to sag to less than 1V once the system is started. Therefore, the battery voltage range is from $V_{OUT} + V_{diode}$ to less than 1V (where V_{diode} is the forward drop of the Schottky rectifier). If the battery voltage exceeds the programmed output voltage, the output will follow the battery voltage. In many systems this is acceptable; however, the output voltage must not be forced above 7V.

The main regulator's peak-current limit is internally fixed at 1A \pm 0.2A. The switching frequency depends on load and input voltage, and can range as high as 500kHz for the main SMPS.

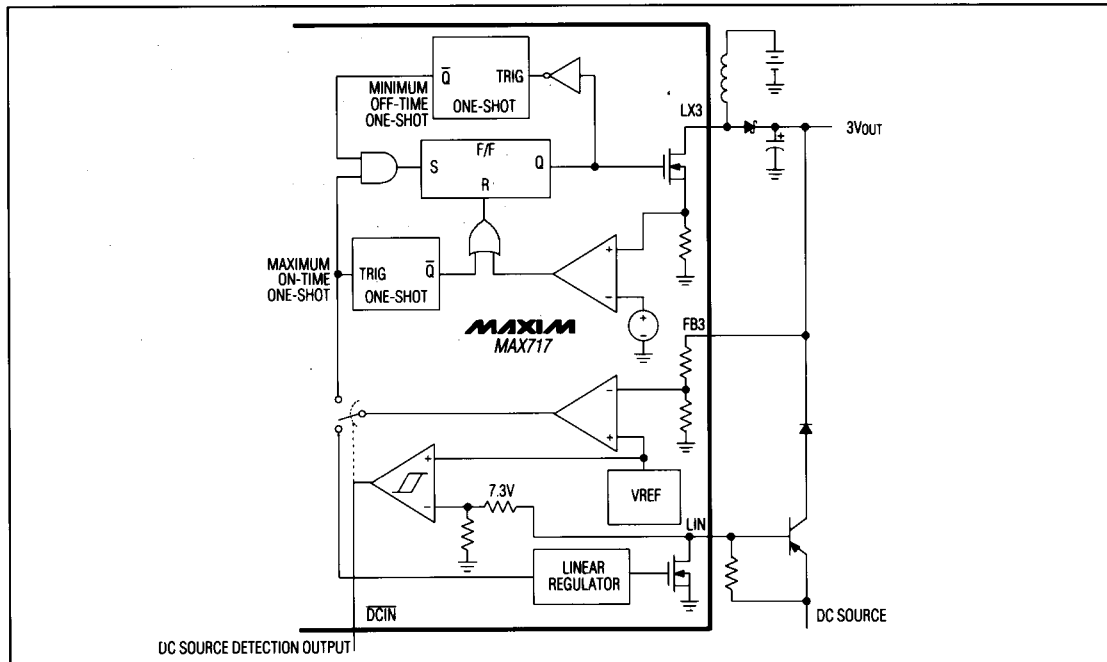

Figure 3. Main SMPS Block Diagram

Palmtop Computer and Flash Memory Power-Supply Regulators

MAX717-721/EV KIT

Backup Switch-Mode Regulator

The backup switching-regulator output (MAX717, MAX718, and MAX719 only) is controlled by the main feedback resistors and comparator, and is otherwise very similar to the main regulator except for a greatly reduced peak-current limit (5mA ±30%). It works well with tiny 1210-size 220μH chip inductors, but slightly better efficiency and higher output power can be achieved with a larger 1812-size 1mH inductor.

With lithium backup batteries, place an extra 1N914-type diode or resistor in series with D4 in order to comply with Underwriters Laboratories' guidelines for preventing accidental charging.

One method for extending the backup battery's life is to let the main batteries rest for a while, then switch back over until the output goes out of regulation again. External control over the backup mode via BKUP (as opposed to automatic switching) allows different strategies for managing the switchover to be controlled by the system microprocessor.

Auxiliary 5V/12V Switch-Mode Controller

The auxiliary controller operates similarly to the main regulator, except the power transistor and sense resistor are external, and the maximum on-time is set at 8μs. The maximum possible output power is limited by the drive capability of D12. Do not use MOSFETs with greater than 20nC total gate charge, since excessive current drawn from D12 may upset the V+ substrate switchover circuit.

The auxiliary regulator's efficiency is strongly influenced by resistive losses in the ESR of the input/output filter capacitors and the inductor. For highest efficiency, the ESR or DC resistance of each component must be less than 30mΩ. Use 18AWG or heavier bus wire for the battery and ground connections.

The auxiliary SMPS peak-current limit (I_{PEAK}) is set at 200mV/R1 (170mV worst-case low). The equations below calculate R1 based on design parameters.

$$I_{PEAK} = (I_{LOAD}) \left(\frac{V_{OUT} + V_D - V_{BATT}}{V_{BATT} - V_{SW}} + 1 \right) + \frac{(V_{OUT} + V_D - V_{BATT}) (1\mu s)}{2L}$$

$$R1 = \frac{200mV}{I_{PEAK}}$$

where V_D is the rectifier forward voltage and V_{SW} is the average saturation voltage of switch transistor Q1, including the drop across R1.

Example:

$$(70mA) \left(\frac{12V + 0.5V - 2V}{2V - 0.5V} + 1 \right) + \frac{(12V + 0.5V - 2V) (1\mu s)}{2 (22\mu H)} = 798mA$$

$$R1 = \frac{170mV \text{ (worst-case low)}}{798mA} = 0.21\Omega \text{ (or less)}$$

Powering the Auxiliary Supply

Unlike the main output, the auxiliary output is not automatically powered from the linear regulator. The main battery will continue to drain if the auxiliary supply is not turned off when an external DC source is applied. There are several alternative solutions:

1) Power the auxiliary supply from the main output all the time. This leads to compounded efficiency losses and increases the main output's total load, but is simple. These compounded losses are actually not crippling in many cases, especially if the main output is set at 5V.

If the input voltage is 5V when the 5V setting of the auxiliary supply is selected, the auxiliary output is noisy with over 0.5V_{p-p} noise in the standard application circuit. This excess noise is caused by the large amount of energy transferred with each cycle, which is in turn caused by the low input-to-output differential voltage (5V to 5V plus a diode drop). So, if the auxiliary regulator must deliver high currents at 12V as well as good ripple when performing 5V-to-5V conversion, changes to the standard application circuit are needed. Either the input voltage to the auxiliary regulator's inductor must be stepped down with a series 1N4001 diode or similar means, or the filter capacitor on the auxiliary output must have very low ESR, preferably 0.02Ω or less, and must be increased in value to 150μF or more. See *Capacitor Selection* for recommendations.

2) Power the auxiliary supply from the main output in linear-regulator mode, but power it from the battery when the DC source is absent. This provides the best overall efficiency, but requires a relay or MOSFET switch to make the switchover (Figure 4). In most applications, the battery voltage is too low to use P-channel devices for the switchover, but a high-side supply, such as the MAX623 charge-pump regulator (Figure 5), works well with N-channel switches. Switchover can also be accomplished with special AC-DC adapter plugs and jacks with built-in mechanical switches.

3) Use a battery charger that can supply a load while it charges the battery, such as the MAX713. This approach also eliminates the PNP pass transistor for the linear regulator.

Palmtop Computer and Flash Memory Power-Supply Regulators

MAX717-721/EV Kit

Status Outputs

Both status outputs ($\overline{\text{PFO}}$ and $\overline{\text{DCIN}}$) are active-low, open-drain types. Although they are true open-drain types that can be wire-ORed with external logic, they are protected against ESD damage by reverse-biased clamp diodes connecting to $V+$. If the status outputs are pulled up to external supply voltages above the main output voltage level, the pull-up resistor must limit the current through the ESD protection diode to $25\mu\text{A}$ or less to maintain regulation of the outputs.

The $\overline{\text{PFO}}$ comparator senses when the main output is more than 6% out of regulation, and has 2% hysteresis built in to prevent chatter. The $\overline{\text{PFO}}$ comparator is active in all modes except shutdown.

Control-Logic Inputs

The control inputs ($3/\overline{5}$, 12ON , $12/\overline{5}$, and BKUP/SHDN) are high-impedance MOS gates protected against ESD damage by normally reverse-biased clamp diodes. If these inputs are driven from signal sources that exceed the main supply voltage (FB3), the diode current should be limited by a series resistor ($1\text{M}\Omega$ suggested). The logic input-threshold level is the same (approximately 1V) in both 3V and 5V modes. Do not leave the control inputs floating.

Substrate Switchover Circuit

The substrate ($V+$, pin 16) is powered from either the auxiliary +12V output or from the main output, whichever is higher. The substrate serves as the positive supply rail for most internal circuitry, including the reference and the MOSFET driver (D12). When the auxiliary supply is on, an internal regulator forces $V+$ to 4V (to 5V if $12/\overline{5}$ is high or if $3/\overline{5}$ is low). Do not load $V+$. $V+$ must be bypassed to ground with at least $0.1\mu\text{F}$.

Inductor Selection

The inductors must have a saturation (incremental) current rating equal to the peak switch-current limit, which is 1.2A worst-case for the main output and user-adjustable for the auxiliary output. However, it's generally acceptable to bias the inductor deep into saturation by 20% or more.

The inductors' DC resistance significantly affects efficiency. For highest efficiency, limit L1's DC resistance to 0.03Ω or less.

Capacitor Selection

A $100\mu\text{F}$, 10V surface mount (SMT) tantalum capacitor typically provides 50mV output ripple when stepping up 2V to 5V at 200mA. Smaller capacitors, down to $10\mu\text{F}$, are acceptable

for light loads or in applications that can tolerate higher output ripple.

For the auxiliary output, a $47\mu\text{F}$, 16V SMT tantalum capacitor typically provides 150mV output ripple when stepping up 3V to 12V at 60mA. Again, smaller capacitors are acceptable, and in this case the minimum value depends on the current-limit resistor value.

The ESR of both bypass and filter capacitors affects efficiency. Best performance is obtained by doubling up on the filter capacitors or using specialized low-ESR capacitors. The smallest low-ESR SMT tantalum capacitors currently available are Sprague 595D series, which are about half the size of competing products. Sanyo Os-con organic semiconductor through-hole capacitors also exhibit very low ESR.

SPRAGUE: (603) 224-1961 or (207) 324-4140

SANYO: (619) 661-6322

MOSFET Selection

The 12V SMPS MOSFET (Q1) must be a logic-level N-channel type with no more than 20nC maximum total gate charge. If a larger FET with more than 20nC total gate charge is used, D12 must be buffered with a MOSFET driver IC such as a MAX627. Gate drive levels on start-up are determined by the main SMPS's output voltage. If the main SMPS is set at 3V or 3.3V, the 12V SMPS may not start under heavy loads ($>100\text{mW}$) unless the MOSFET has a very low threshold (for example: Motorola MTD3055EL, $V_{\text{TH}} = 2\text{V}$ max). The Siliconix Si9942 MOSFET contains an extra P-channel FET that is useful as a load switch.

PC Layout and Grounding

The MAX717's high peak currents and high-frequency operation make PC layout important for minimizing ground bounce and noise. Use Figure 7's PC layout as a rough guide for component placement and ground connections. The distance between the MAX717's GND and the ground leads of C1 and C5 must be kept to less than 0.2" (5mm). If possible, use a ground plane.

3-Cell Applications

Higher input voltages increase the energy transferred with each cycle, due to the reduced input/output differential. Minimize excess ripple due to increased energy transfer by reducing the inductor value ($10\mu\text{H}$ suggested). Add extra filtering and recalculate the auxiliary regulator's current-limit resistor value according to the equations in the *Auxiliary 5V/12V Switch-Mode Controller* section.

MAX718 Evaluation Kit

EV Kit General Description

The MAX718 evaluation kit (EV kit) is an assembled surface-mount demonstration board. The kit embodies the standard 2-cell application circuit of Figure 1, and adds a DIP switch and 3M Ω pull-up resistors for each control input. A MAX718 comes installed on the board, but it also accommodates a MAX717 or MAX719 footprint. To replace the MAX718 IC, first cut the leads free of the package, then carefully desolder the leads individually.

Operating Instructions

For highest efficiency, connect heavy-gauge (18AWG) stranded wire from the battery terminals to a 2A adjustable supply or 2-cell battery pack.

Important: Connect BATT1 and BATT2 together with heavy wire to ensure both SMPS regulators work. If BATT1 is powered separately from BATT2, connect an extra input bypass capacitor across BATT1 (not included). Otherwise, there is no filtering at BATT1 and poor efficiency results.

Adjust the supply up to two or three volts. Set the BKUP and 3/5 switches low, and measure the main output voltage. Load the outputs and observe the switching waveforms at LX3 and D12.

MAX718 EV Kit Component List

(Circuit of Figure 1)

DESIGNATION	QTY	DESCRIPTION	SOURCE
C1	1	100 μ F, 10V E-size SMT tantalum capacitor	Matsuo 267M1002-107
C2	1	47 μ F, 16V E-size SMT tantalum capacitor	Matsuo 267M1602-476
C3	1	0.22 μ F 1206-size ceramic capacitor	Murata-Erie GRM42-6X7R224K025V
C4	1	0.1 μ F 1206-size ceramic capacitor	Murata-Erie GRM42-6X7R104K025V
C5	1	150 μ F, 6.3V E-size SMT tantalum capacitor	Matsuo 267M6301-157
L1, L2	2	22 μ H, 1A SMT inductors	Sumida CD54-220
L3	1	220 μ H 1210-size chip inductor	Sprague GLA22110
R1	1	0.22 Ω \pm 10% 1206-size chip resistor	Ohmtek L1206LR220LBT or IMS RC-I-1206
R2	1	330 Ω \pm 5% 1206-size chip resistor	
D1, D2	2	1A Schottky rectifiers, 1N5817 equivalent	NIEC EC15QS02L
D3	1	1A silicon rectifier, 1N4001 equivalent	NIEC EC10DS1
D4	1	Signal diode	Motorola 1N4148 or 1N914
Q1	1	0.25 Ω logic-level N-channel MOSFET, SO-8 package	1/2 Siliconix Si9942DY
Q2	1	Power PNP transistor, D-PAK	Motorola MJD2955

IMS	(401) 683-9700	NIEC Japan	(81) 3-3494-7411
Matsuo USA	(714) 969-2491	Ohmtek	(716) 283-4025
Matsuo Japan	(06) 332-0871	Siliconix	(408) 988-8000
Motorola	(602) 244-6900	Sprague	(516) 746-1385
Murata-Erie	(404) 436-1300	Sumida USA	(708) 956-0666
NIEC	(805) 867-2555	Sumida Japan	(03) 3607-5111

MAX718 Evaluation Kit

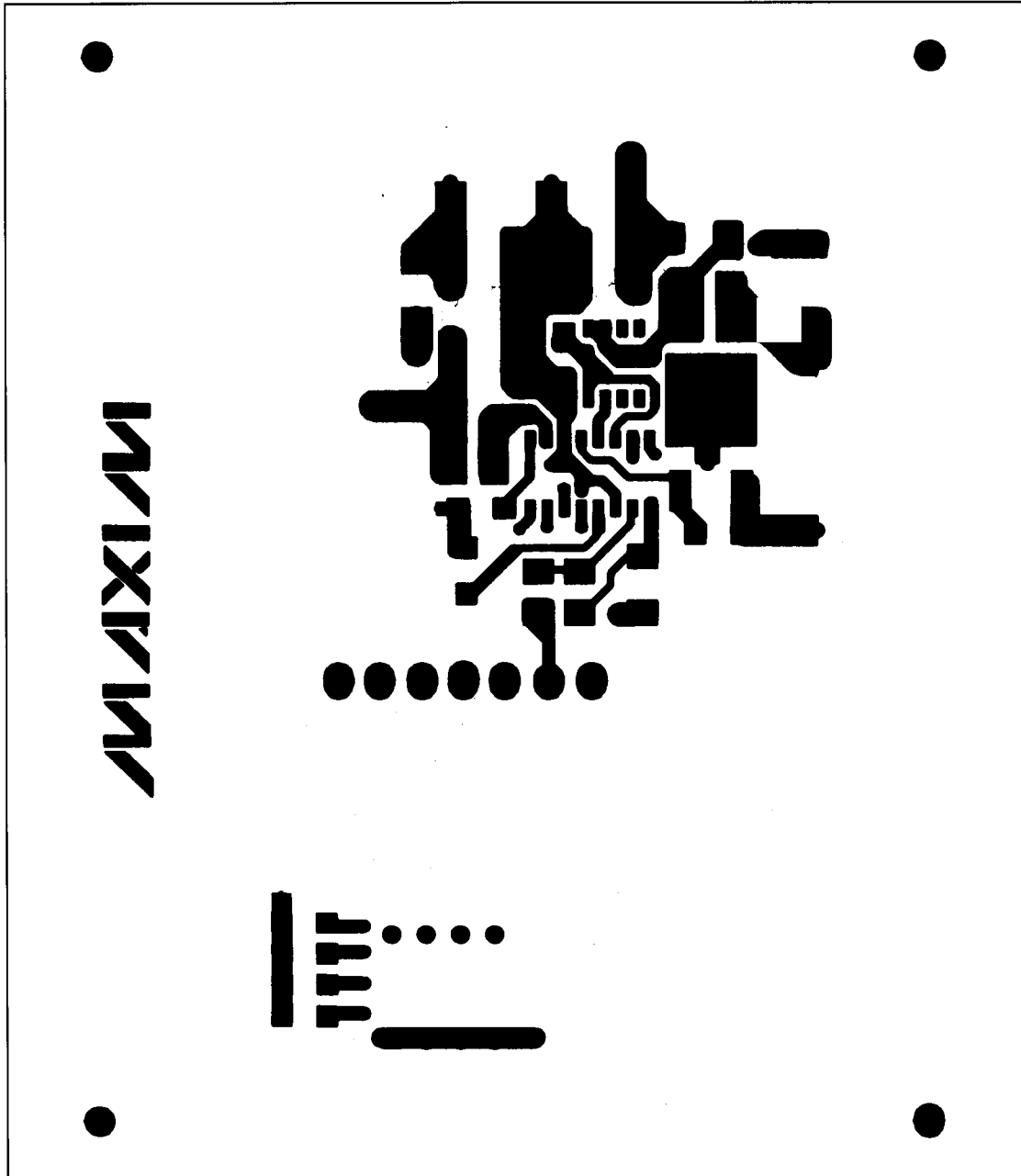

Figure 7. MAX718 EV Kit Printed Circuit Layout (2X Scale, Component Layer, Component Side View)

MAX718 Evaluation Kit

MAX717-MAX721/EV Kit

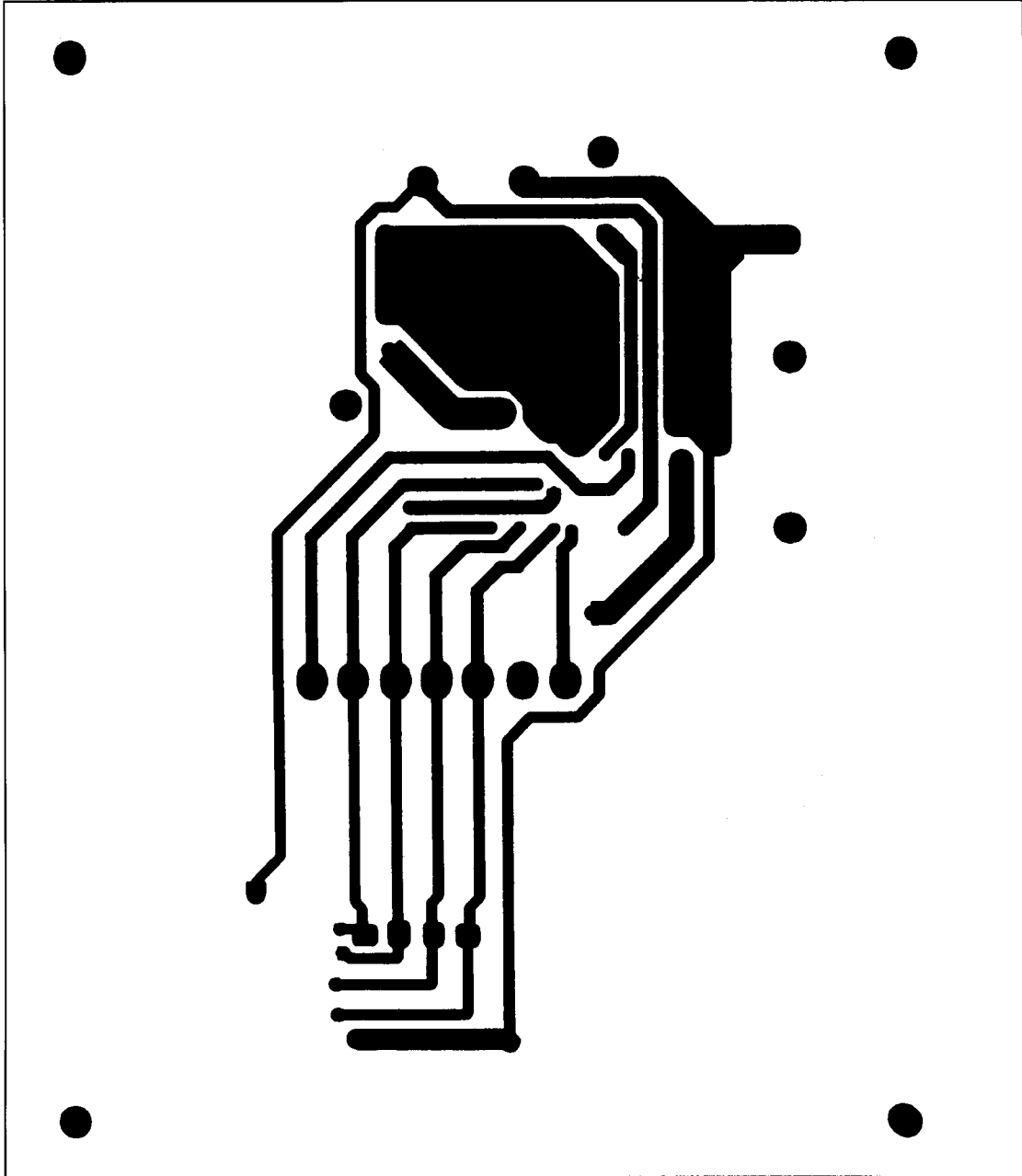

Figure 8. MAX718 EV Kit Printed Circuit Layout (2X Scale, Bottom Layer, Component Side View)

MAX718 Evaluation Kit

MAX717-MAX721/EV Kit

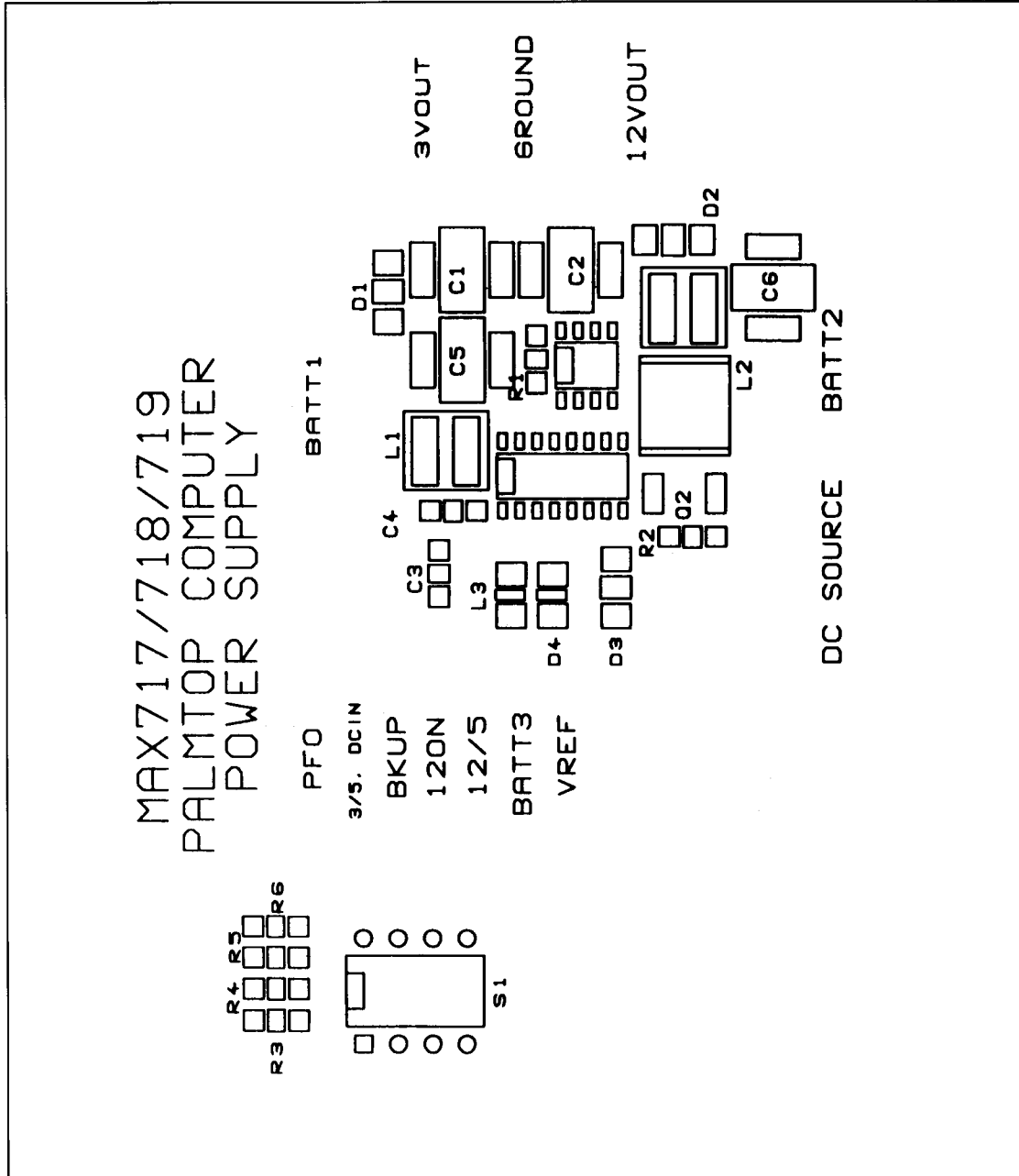

Figure 9. MAX718 EV Kit Component Placement Diagram

MAX718 Evaluation Kit

EV Kit

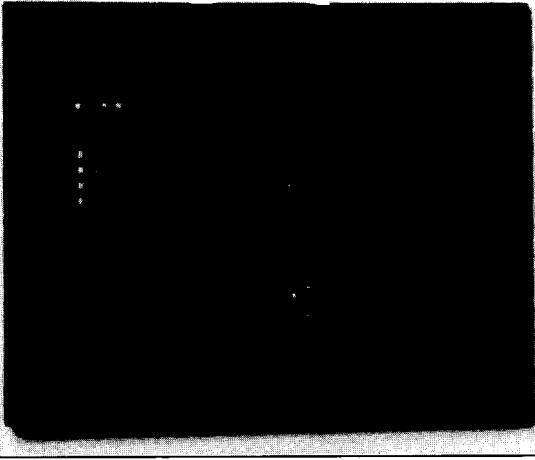
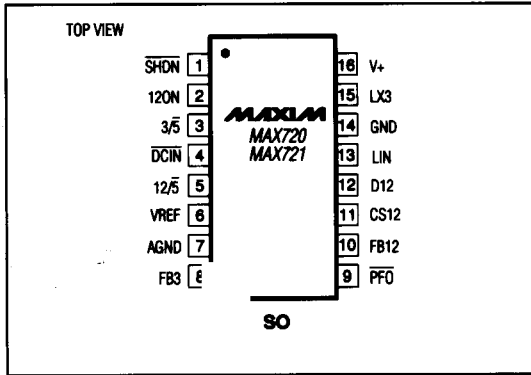

Figure 10. MAX718 EVKIT-SO can also be fitted for the MAX717 and MAX719.

Pin Configurations (continued)



Chip Topography

Ordering Information (continued)

PART	TEMP. RANGE	PIN-PACKAGE
MAX717ESE	-40°C to +85°C	16 Narrow SO
MAX718CSE	0°C to +70°C	16 Narrow SO
MAX718C/D	0°C to +70°C	Dice*
MAX718ESE	-40°C to +85°C	16 Narrow SO
MAX719CSE	0°C to +70°C	16 Narrow SO
MAX719C/D	0°C to +70°C	Dice*
MAX719ESE	-40°C to +85°C	16 Narrow SO
MAX720CSE	0°C to +70°C	16 Narrow SO
MAX720C/D	0°C to +70°C	Dice*
MAX720ESE	-40°C to +85°C	16 Narrow SO
MAX721CSE	0°C to +70°C	16 Narrow SO
MAX721C/D	0°C to +70°C	Dice*
MAX721ESE	-40°C to +85°C	16 Narrow SO
MAX718EVKIT-SO	0°C to +70°C	Surface-Mount Evaluation Board

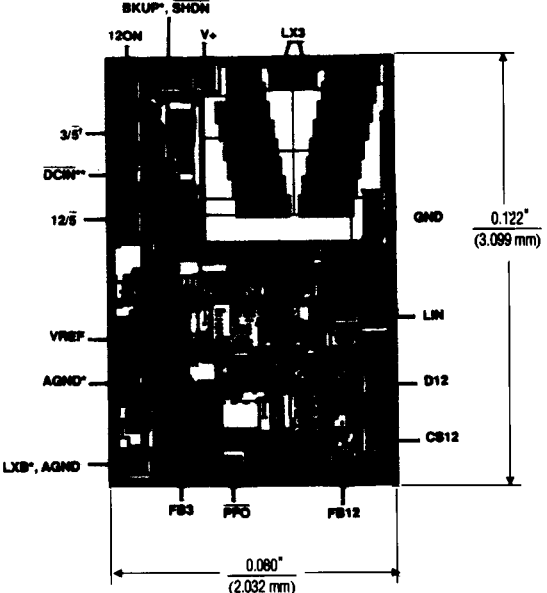

* MAX717/MAX718/MAX719 ONLY.
 ** MAX717/MAX720/MAX721 ONLY.
 † ALL EXCEPT MAX717.
 SUBSTRATE CONNECTED TO V+;
 TRANSISTOR COUNT: 764.

Maxim cannot assume responsibility for use of any circuitry other than circuitry entirely embodied in a Maxim product. No circuit patent licenses are implied. Maxim reserves the right to change the circuitry and specifications without notice at any time.